

6

5

4

3

2

1

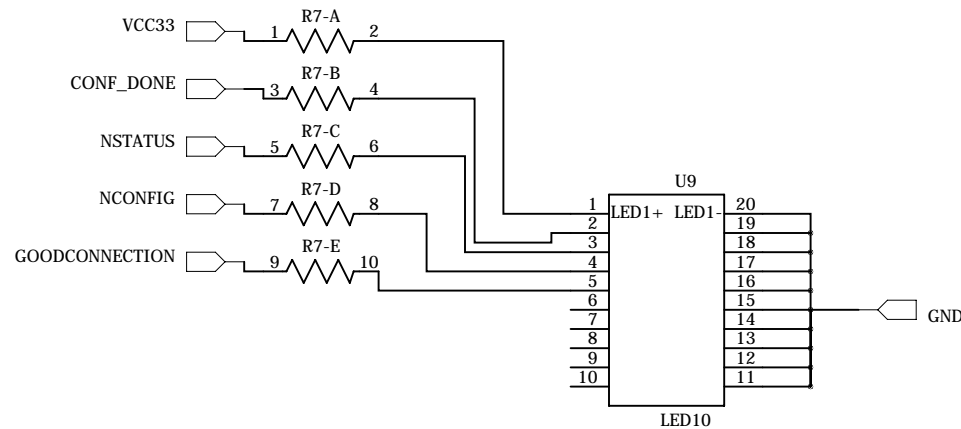
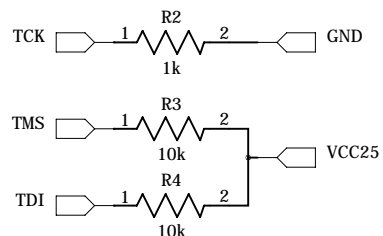
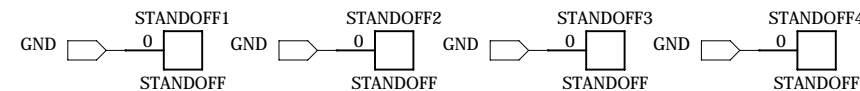

REVISION RECORD			
LTR	ECO NO:	APPROVED:	DATE:

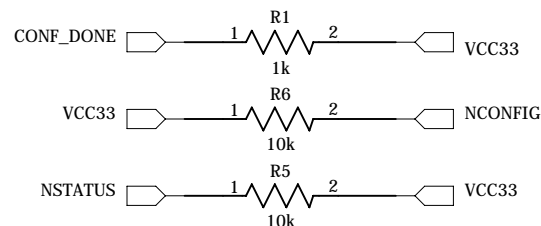
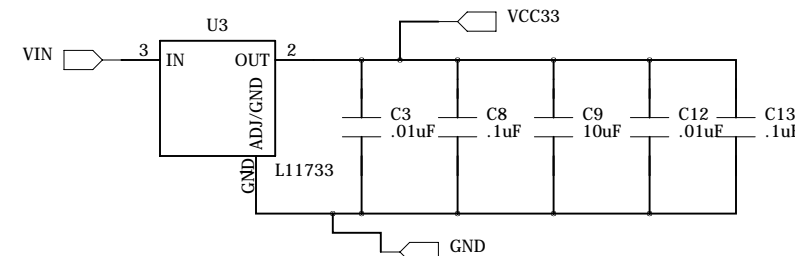
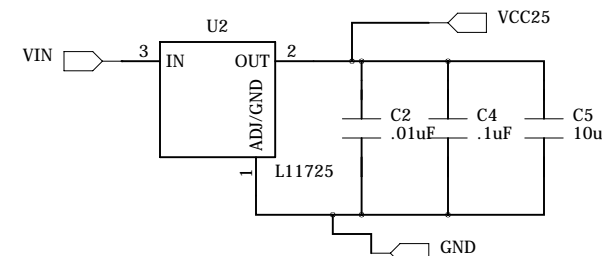
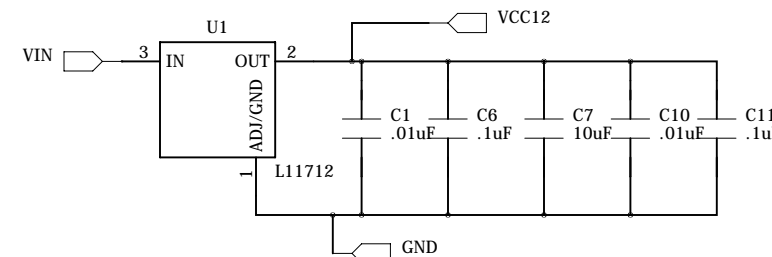
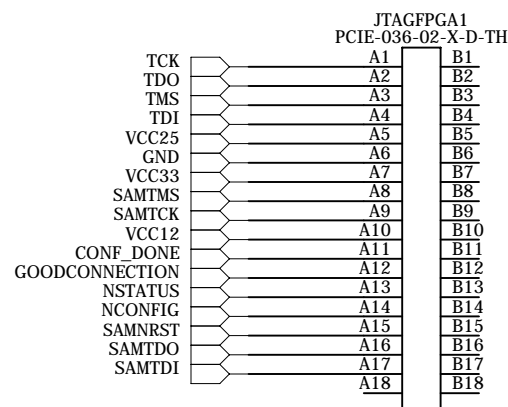
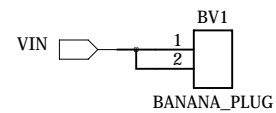
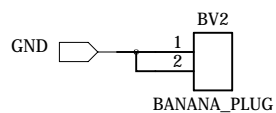
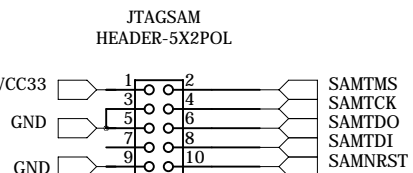
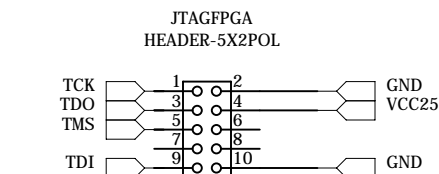

COMPANY: **HMC Engineering**

TITLE: **uMudd Mark V Tester Board**

DRAWN: K. Pezeshki	DATED: December 5th, 2018
CHECKED: <Checked By>	DATED: <Checked Date>
QUALITY CONTROL: <QC By>	DATED: <QC Date>
RELEASED: <Released By>	DATED: <Release Date>

CODE:	SIZE:	DRAWING NO:	REV:
<Code>	B	<Drawing Number>	<Revision>
SCALE: <Scale>			SHEET: 1

D

D

C

C

B

B

A

A